

DC SERVO Motor

KL34-170-72

UNIT=MM:

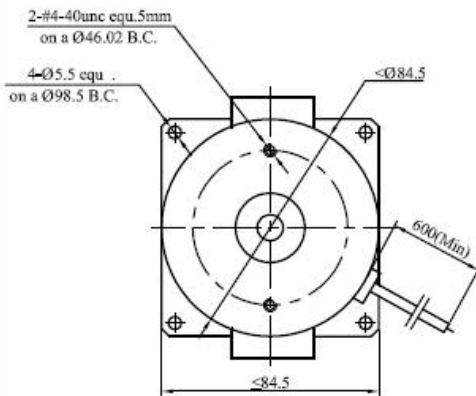
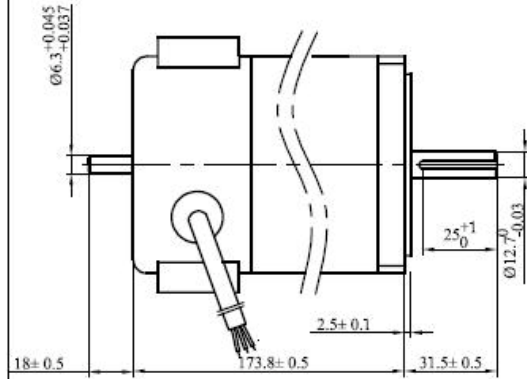
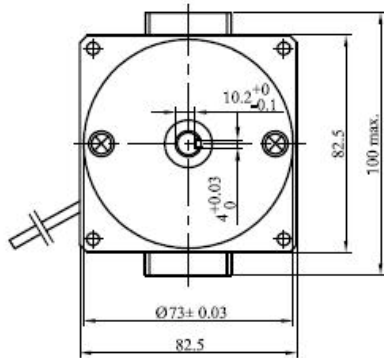

-Skewed Rotor Design

-constant torque: 1.2 N.m (170 oz-in)

-peak torque: 6.0 N.m (850 oz-in)

-max. speed at voltage constant: 4200 rpm

-terminal voltage: 72 VDC

-continuous current: 7.5A

-peak current: > 30 A

-torque constant (KT): 0.1791 Nm/am

-voltage constant(KE): 18.75 V/100rpm

-resistance: 0.85 ohm

-inductance: 2.35 mh

-inertia: 3.39 kg/cm²

-weight: 4kg