

Introduction

VSD-E Parallel interface is a **breakout board** designed to ease connection of up to four VSD-E drives in single D-Sub 25 connector. Connector pin-out has been designed for **step/dir** operation from popular CNC controllers such as **Mach3**, **EMC2** and **SmoothStepper**.

On-board features

- 1 to 4 axis VSD-E interface with direct ribbon cables
- Easy to install, no messy wiring
- Safety charge-pump.
- E-Stop input
- 10A 250VAC relay + external relay control output
- Full high speed optoisolation with VSD-E
- Drive fault status forwarded to PC
- Drive disable & enable from PC
- Home switch signals routed from VSD-E's to PC
- Powered from PC USB
- Lacking **charge-pump** signal, **fault on any drive** or hitting **E-Stop** button will
 - Disable all drives
 - Disable relays
 - Set logic 0 status to D-Sub pin 10 (fault or E-stop condition signaled to PC)



Installation

Physical overview

Inspect the following illustration of VSDEPI physical construction.

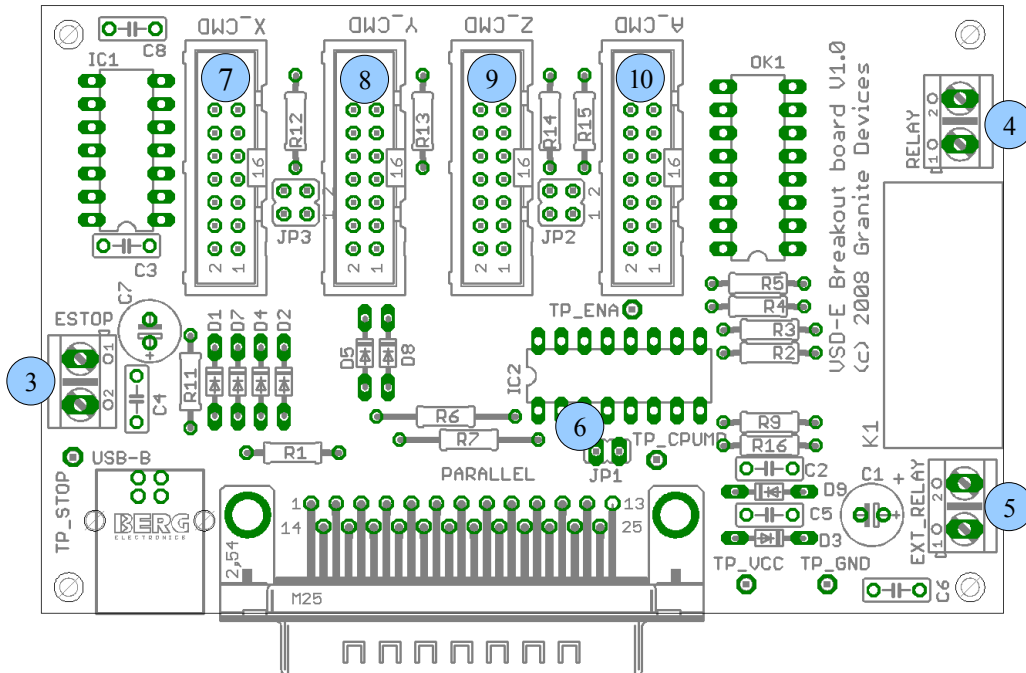

Figure 1: VSDEPI physical overview

| Location in Figure 1 | Description |
|----------------------|-------------------------------------------------------------------------------------------------|
| 1 (USB-B) | USB connector for 5V power input (USB-B connector type) |
| 2 (PARALLEL) | 25 pin male D-Sub connector for control input/output signals |
| 3 (ESTOP) | E-Stop switch input terminal. Normally open switch may be connected to this input. |
| 4 (RELAY) | Relay terminal. Up to 10A 250VAC load can be powered through this connector. |
| 5 (EXT_RELAY) | External relay output. 5 Volt relay coils of external relay can be connected to this connector. |
| 6 (JP1) | Charge pump setting jumper. Charge pump feature is disabled when jumper is inserted. |
| 7 (X_CMD) | X axis drive output. Direct 16 pin flat ribbon cable connection to VSD-E or VSD-XE. |
| 8 (Y_CMD) | Y axis drive output. Direct 16 pin flat ribbon cable connection to VSD-E or VSD-XE. |
| 9 (Z_CMD) | Z axis drive output. Direct 16 pin flat ribbon cable connection to VSD-E or VSD-XE. |
| 10 (A_CMD) | A axis drive output. Direct 16 pin flat ribbon cable connection to VSD-E or VSD-XE. |

GDtool settings for VSDEPI

For correct operation VSDEPI requires several VSD-E or VSD-XE drive configuration parameters to be set properly. **This guide assumes that drive has been correctly configured & tuned for motor.** To load correct VSDEPI settings to drive, follow these steps:

1. Download **VSDEPI_config.zip** from VSDEPI product page and extract its contents
2. **Open GDtool** and connect it to drive by choosing **Device -> Connect to drive**
3. Import drive settings when asked or import manually by choosing **Device -> Import settings from drive**
4. Load VSDEPI settings by choosing **File -> Open** and choosing the *GDtool_VSDEPI_config.drc*
5. Press **Set**
6. Choose **Device -> Save active settings in drive**
7. Repeat these instructions for every drive that will be connected to VSDEPI

Loading VSDEPI_config.drc will modify only following settings: **Motor control mode, Drive pulse input mode** and all **User I/O** settings. All of these settings are located in **General settings** page.

Other settings are do not affect VSDEPI functionality. However, user may need to adjust **Trajectory planner input scaling** to match step pulse frequency to controller frequency capabilities. One may also want to enable **Enable input filtering** from General settings page to filter input pulses for smoother operation.

Making first connections

This manual assumes that you have already **working configuration saved in VSD drives** (including *GDtool_VSDEPI_config.drc*).

For basic installation, follow the given steps

- **Connect a VSD-E/VSD-XE drive** to one of VSDEPI axis outputs by **16 pin flat ribbon cable**
- **Connect an E-stop switch** to ESTOP connector (optional)
- **Configure chargepump jumper:** Insert jumper JP1 if charge pump feature is not being used or leave open if chargepump activated
- **Connect 25 pin D-Sub parallel cable** to controller (PC or SmoothStepper) port
- **Connect USB cable** from PC USB port to VSDEPI (to supply power to VSDEPI)

Mach3 settings for VSDEPI

Follow the images and configure Mach3 accordingly.

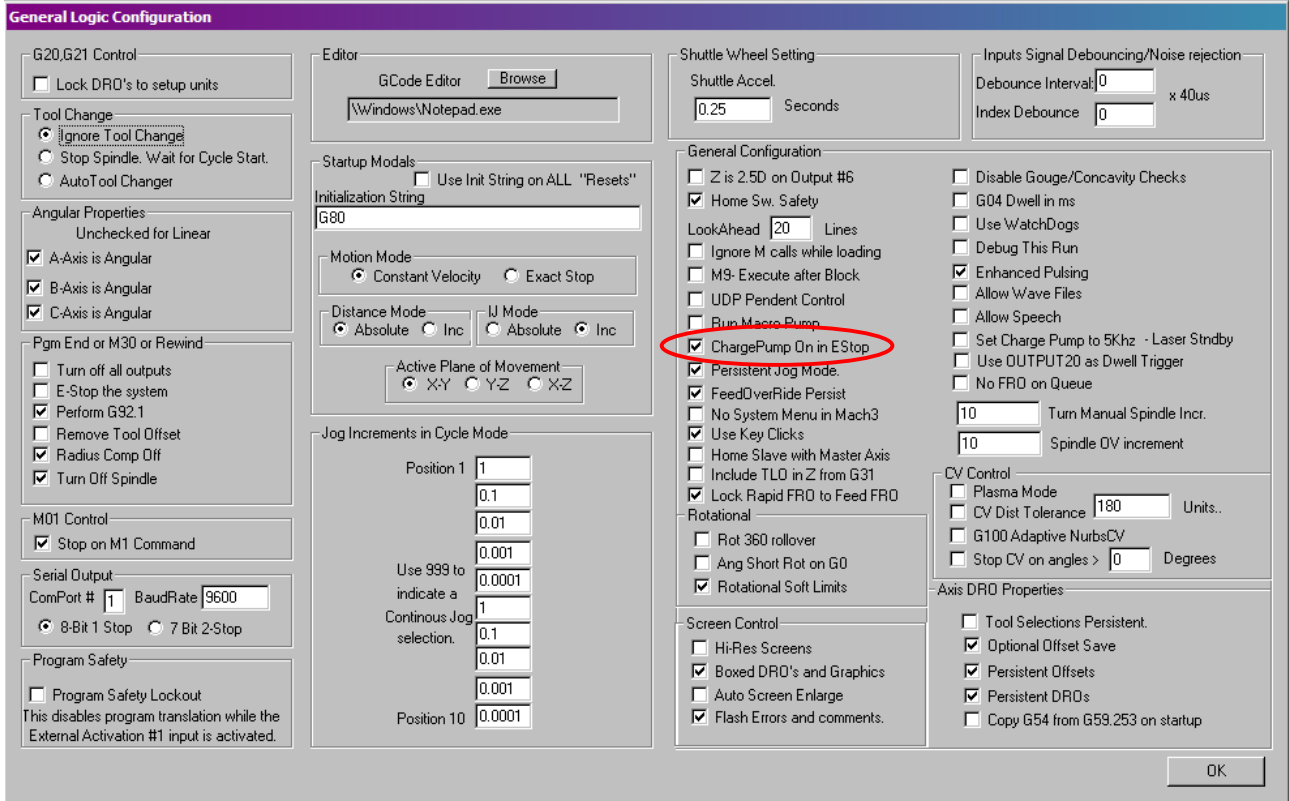

Figure 2: Mach3 general settings dialog. Correct **chargepump** setting circled.

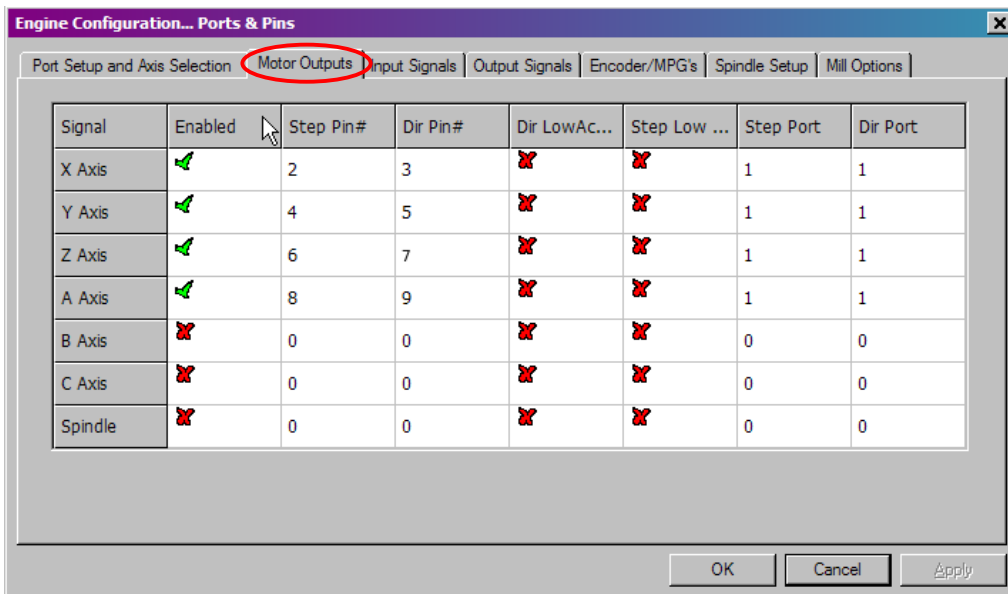
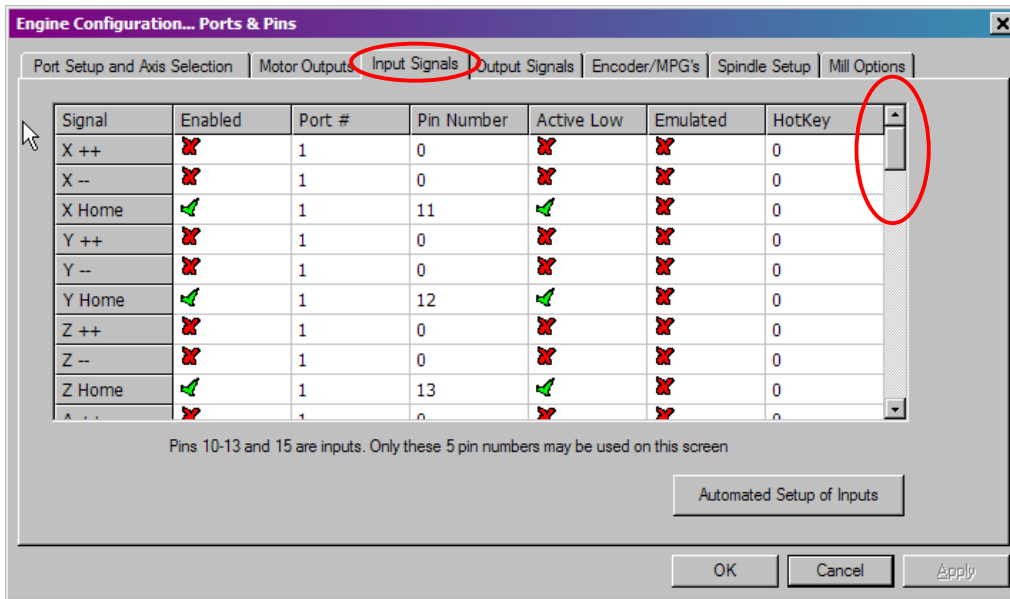

Figure 3: Mach3 **step/dir** configuration for 4 axes.



Not pictured (but also needed): **A Home** = Pin number 15, active low.

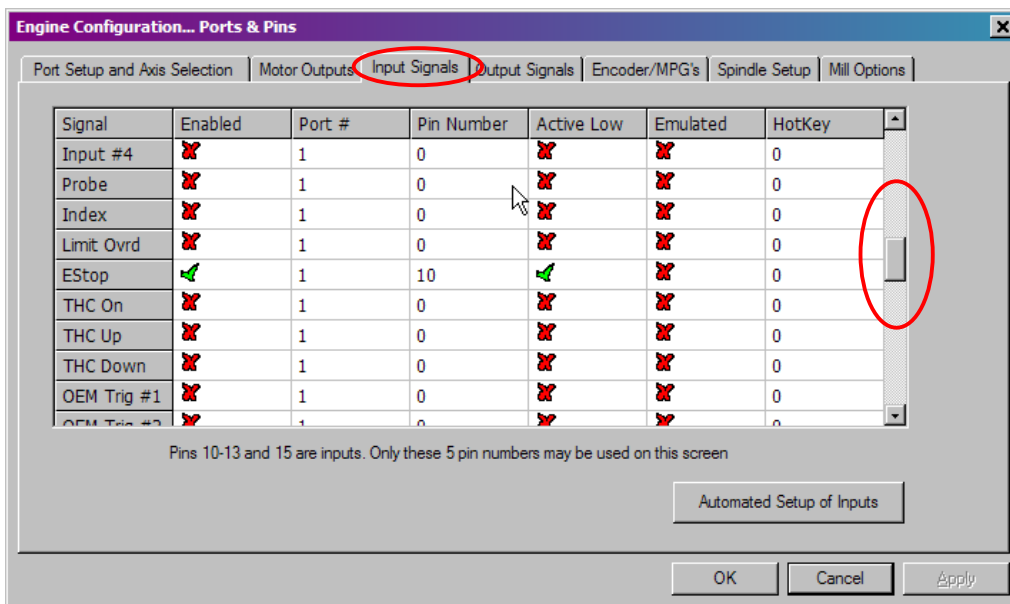

Figure 4: Mach3 input pin settings for **home switches** and **E-stop** (or drive fault). Note that home switch inputs can also be configured differently for different kind of setups (for example use as limit switches).

VSDEPI VSD-E Parallel Interface breakout board

Manual Ver. 0.9

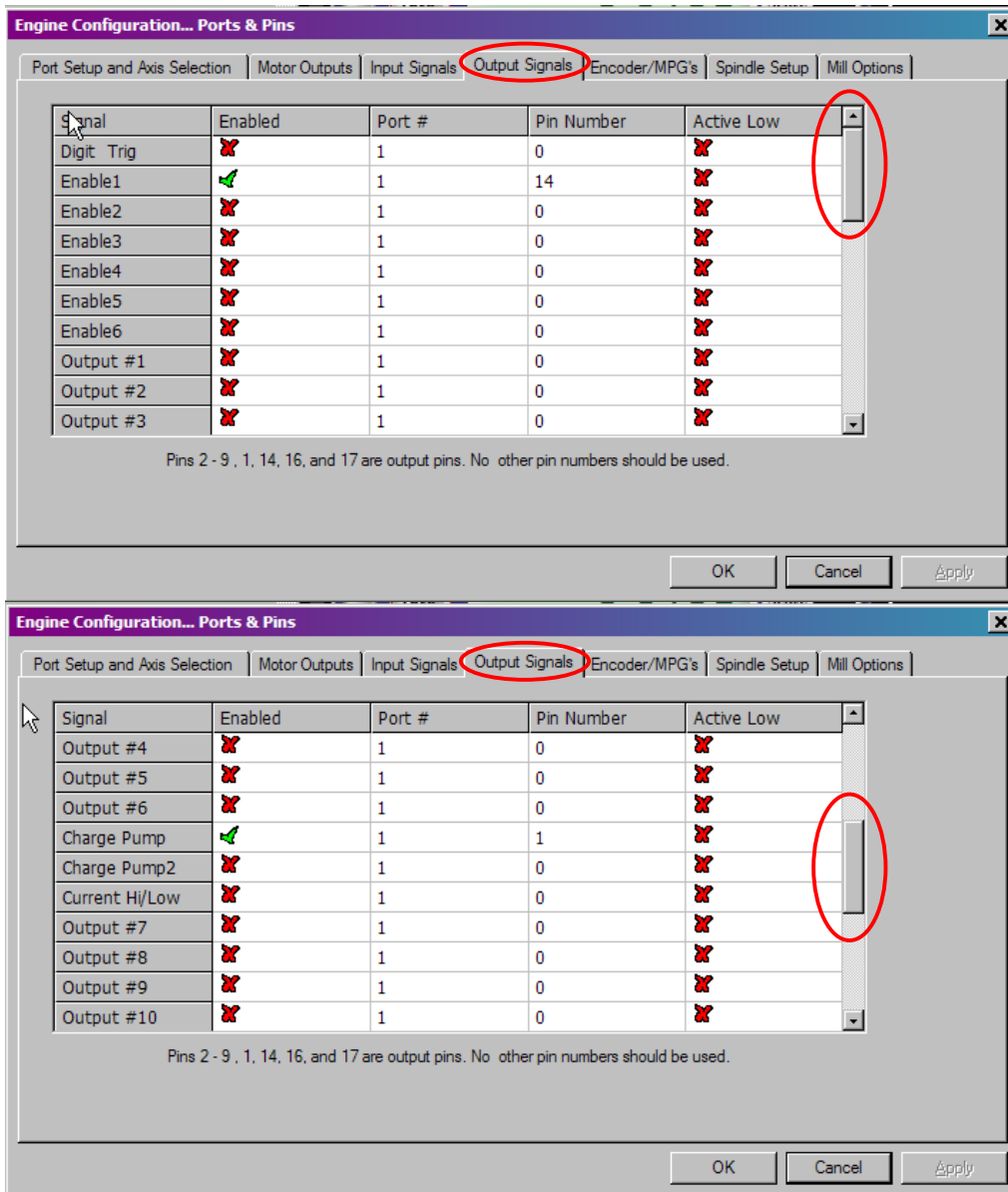

Figure 5: Mach3 output pin settings. **Enable** & **chargepump** signals.

SmoothStepper settings

Ensure that noise filter settings are correct. You may adjust frequencies to match your motor resolution & speed.

Note: there is bug in SS plugin chargepump support! See troubleshooting.

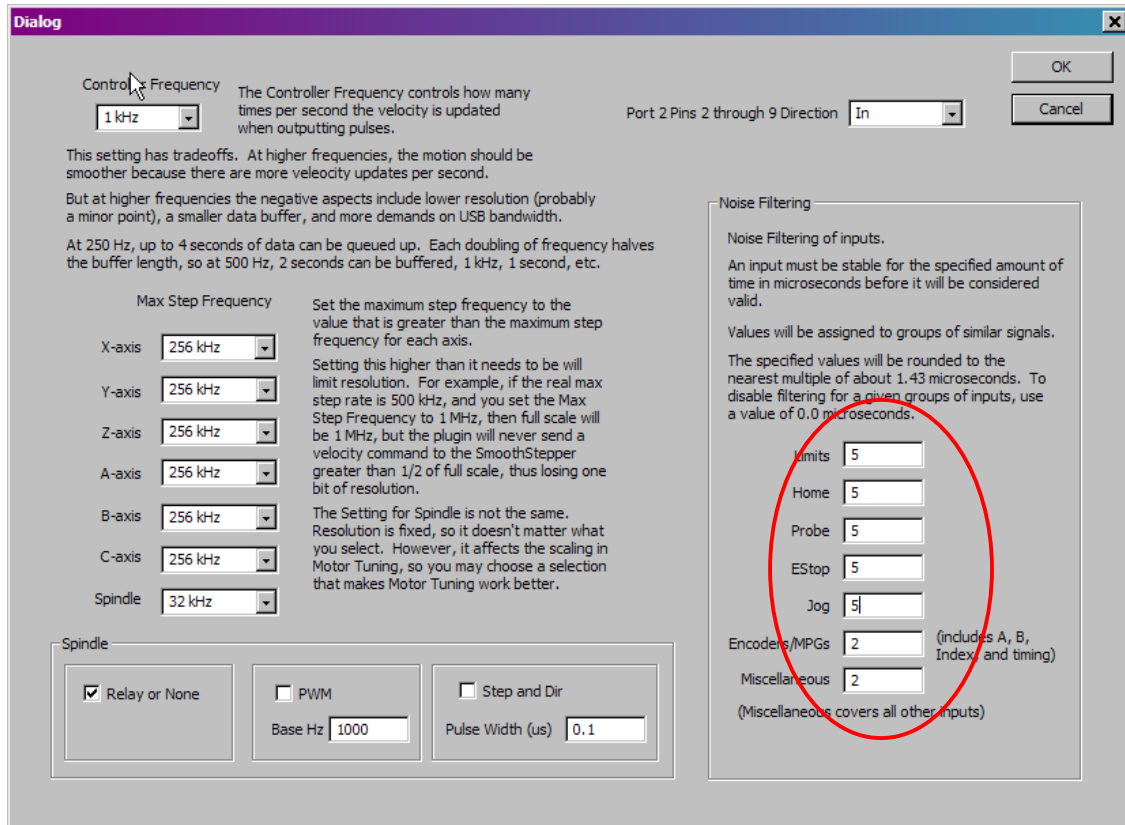

Figure 6: SmoothStepper plugin V0.13 settings. Ensure correct **noise filter** settings.

D-Sub pin-out

Configure your CNC control software pinout accordingly

| Parallel port pin | Function |
|--------------------------|---------------------------------------------------------------------------------------------------------------------|
| 1 | Charge pump input (feed 10-30 kHz frequency to this input or insert jumper JP1 to disable this feature) |
| 2 | X axis direction |
| 3 | X axis step (rising edge) |
| 4 | Y axis direction |
| 5 | Y axis step (rising edge) |
| 6 | Z axis direction |
| 7 | Z axis step (rising edge) |
| 8 | A axis direction |
| 9 | A axis step (rising edge) |
| 10 | Drive fault & E-stop input to PC (active low). Also low when charge pump signal was not detected while JP1 is open. |
| 11 | X home switch to PC. Routed from VSD encoder connector, connect actual switch to VSD-E/XE home switch input. |
| 12 | Y home switch to PC. Routed from VSD encoder connector, connect actual switch to VSD-E/XE home switch input. |
| 13 | Z home switch to PC. Routed from VSD encoder connector, connect actual switch to VSD-E/XE home switch input. |
| 14 | Drive enable from PC (drives active when high, disabled when low) |
| 15 | A home switch to PC. Routed from VSD encoder connector, connect actual switch to VSD-E/XE home switch input. |
| 16 | On-board relay control input. Relay on when high. |
| 17 | External relay control input. Relay on when high. |
| 18-25 | Ground |

Troubleshooting

Drives are always disabled or charge pump is not functioning properly

- Check that JP1 is set correctly: *removed if charge pump is being used or inserted when not used.*
- Ensure that all connected drives have correct VSDEPI configuration saved in them.
- Ensure that flat ribbon cables are assembled in correct polarity (pin 1 from VSDEPI goes to pin 1 in drive etc).
- Measure voltage on board: negative voltmeter lead to TP_GND and positive lead to TP_VCC. Voltmeter reading should be between 4.5 and 5.5 VDC.

VSDEPI board is not working properly when JP1 is removed (chargepump is enabled)

- Ensure that charge pump signal is present from PC to D-Sub pin 1
- Measure voltage from on-board test pads: negative voltmeter lead to TP_GND and positive lead to TP_CPUMP. When charge pump is operating properly, the voltage between these pins should be below 1 VDC.
- Make sure that you have checked **Chargepump On in Estop** from Mach3 **Config->General Config** menu
- If you are using SmoothStepper, the above option does not have effect due to SS driver bug. To workaround this, insert JP1 (disable chargepump).

Important notices

Granite Devices is not responsible for possible damages or losses caused by this document, VSDEPI or supplied files. VSDEPI, this information or supplied files should not be used in applications where malfunction may result to injury, death or large financial losses.