

KL-5000

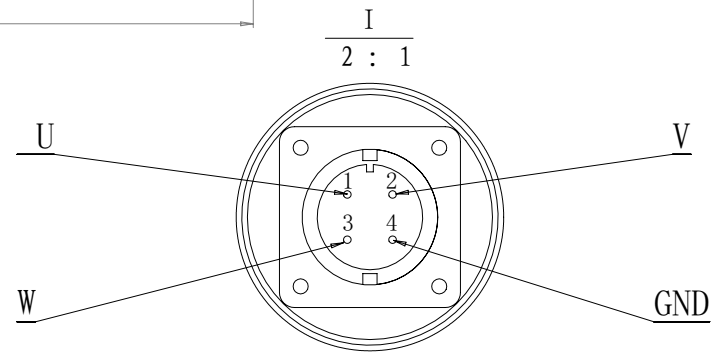
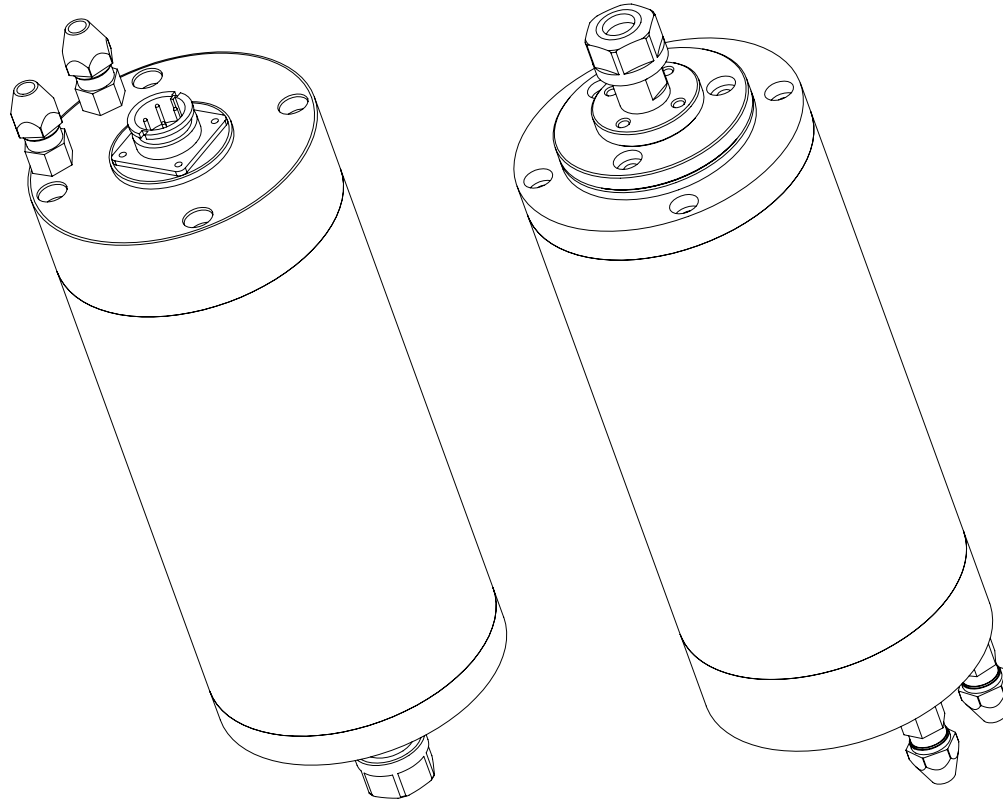
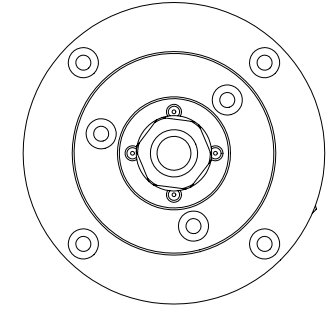
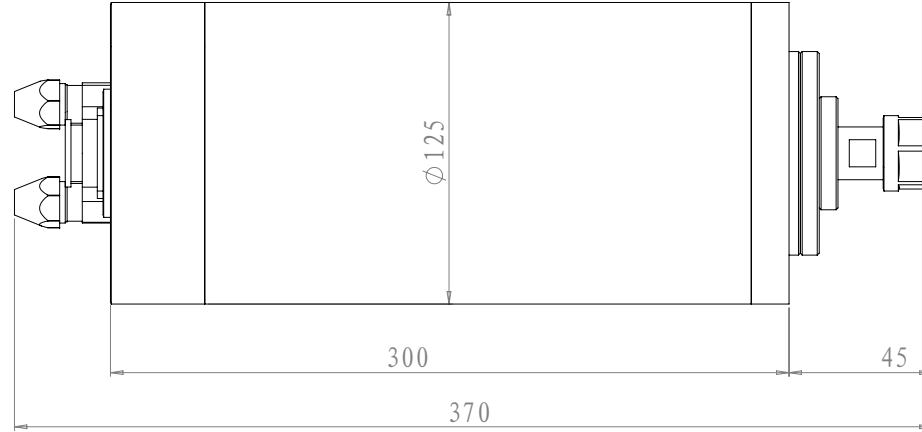
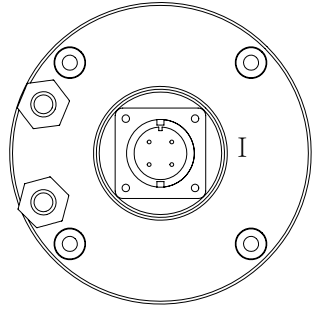

OD=125 MM , 300 MM length

Voltage: 380V

Speed: 5000-24000 R/min

Power: 4500~5000 W

Frequency: 400 Hz

Water Cooling, ER collet chuck

Grease Lubrication, NSK Bearing

Keling Technology Inc
www.kelinginc.net