

KL-3000

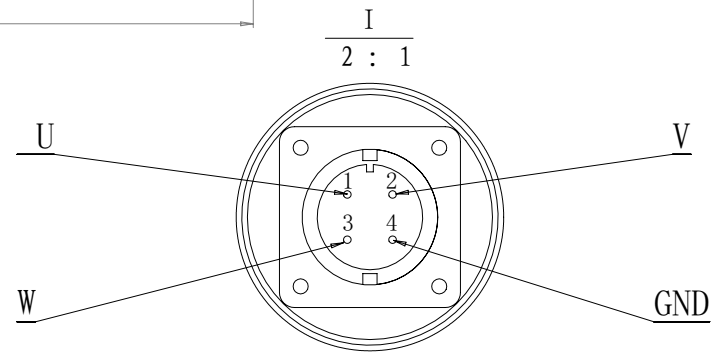
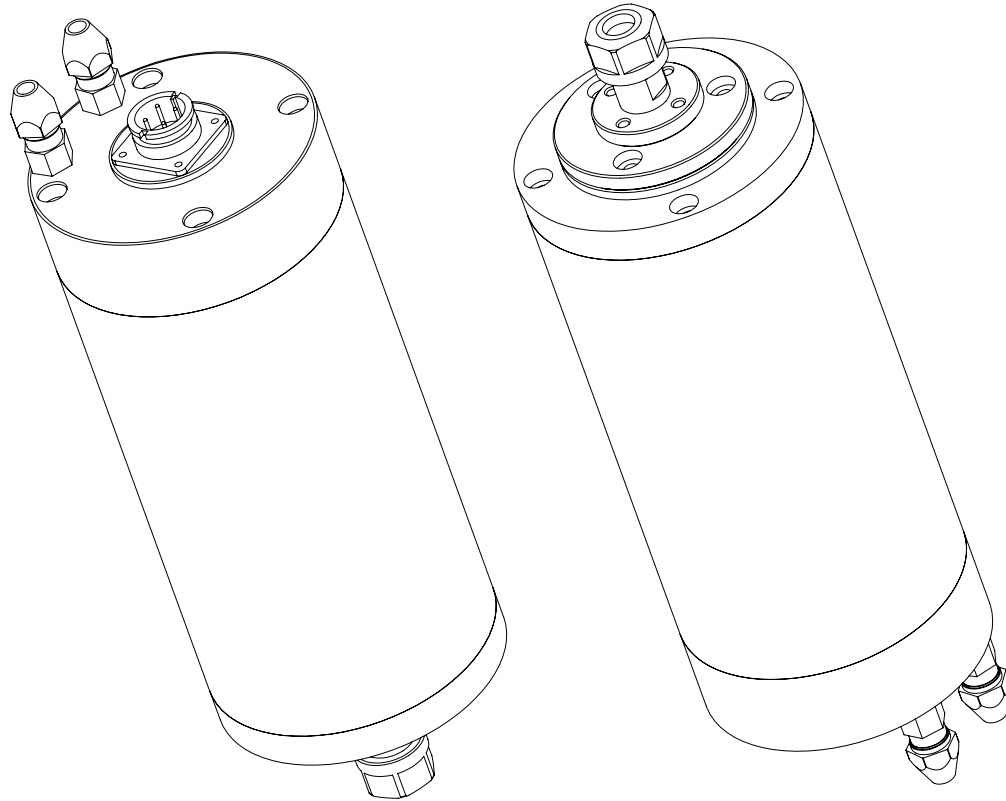
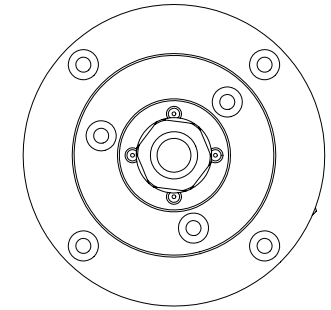
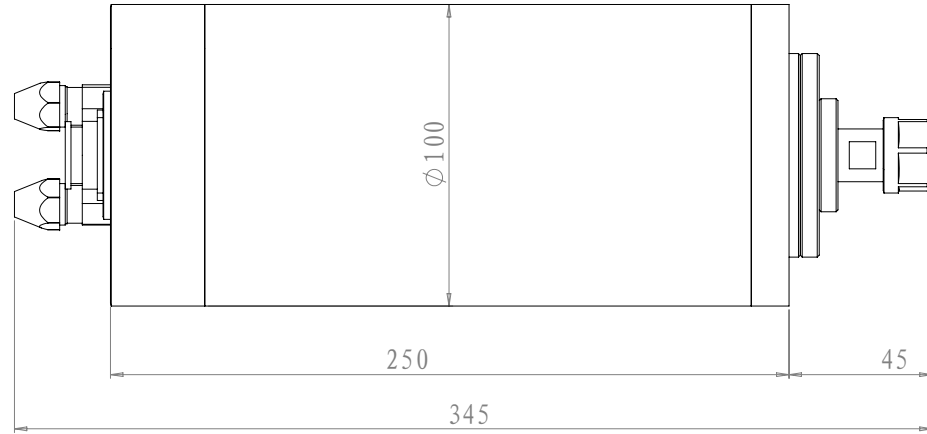
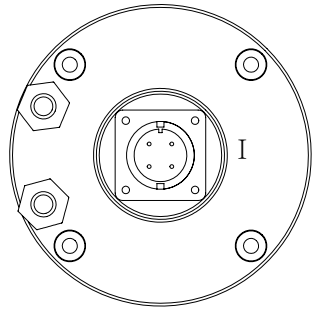

OD=100 MM , 250 MM length

Voltage: 380V

Speed: 10000-24000 R/min

Power: 2500~3000 W

Frequency: 400 Hz

Water Cooling, ER collet chuck

Grease Lubrication, NSK Bearing

Keling Technology Inc
www.kelinginc.net