

KL-2200

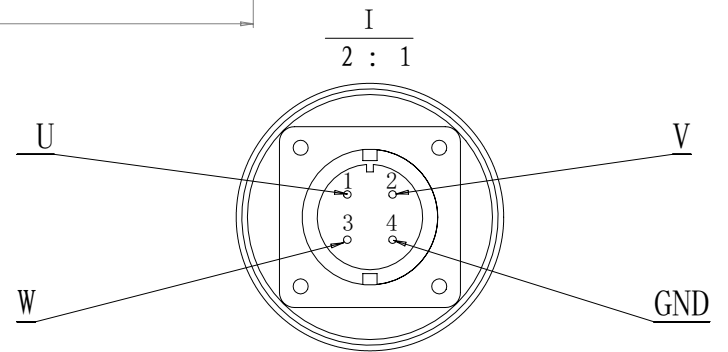
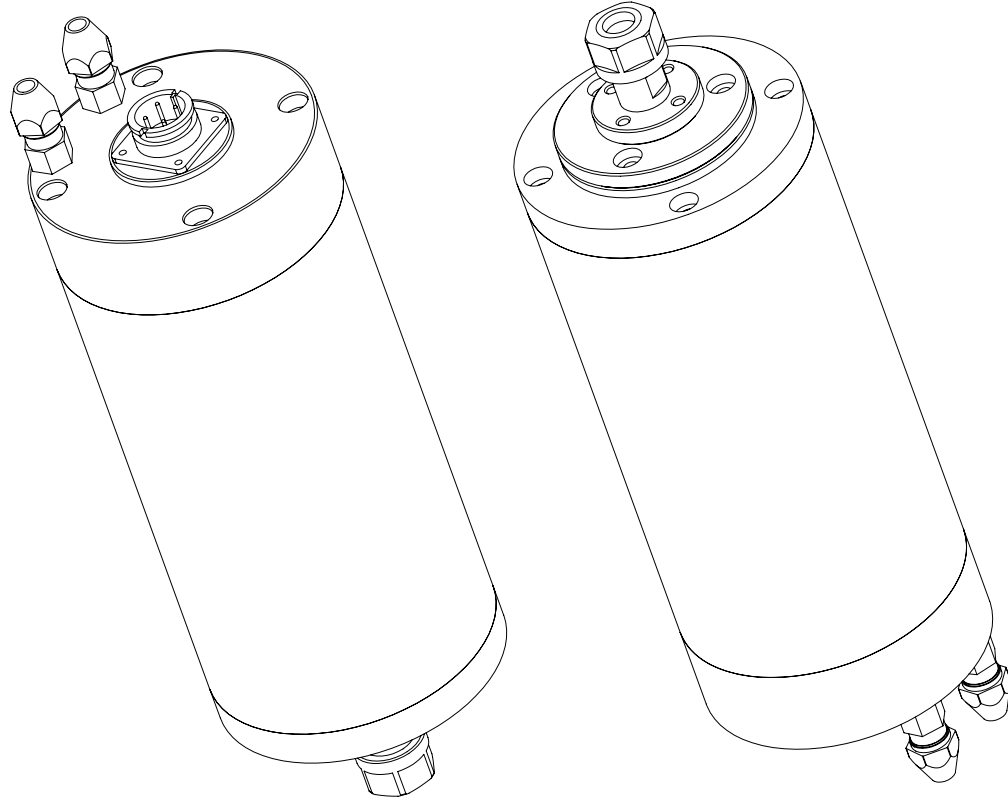
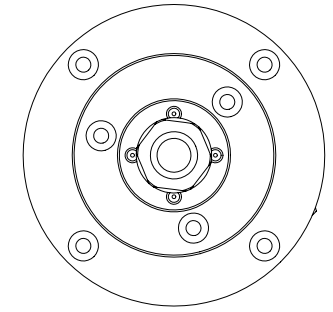
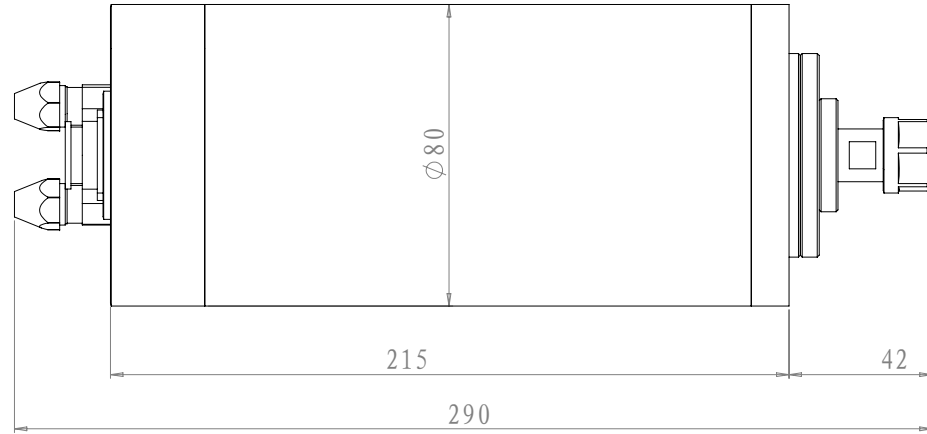
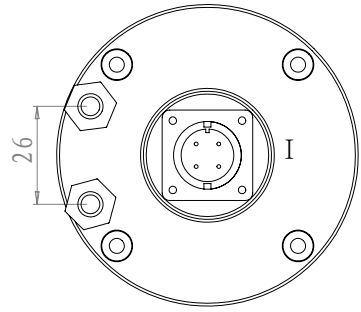

OD=80 MM , 215 MM length

Voltage: 220V

Speed: 8000-24000 R/min

Power: 2200 W

Frequency: 400 Hz

Water Cooling, ER20 collet chuck

Grease Lubrication, NSK Bearing,

Water cooling at 20-26 gal/hr

Keling Technology Inc
www.kelinginc.net