

KL-100

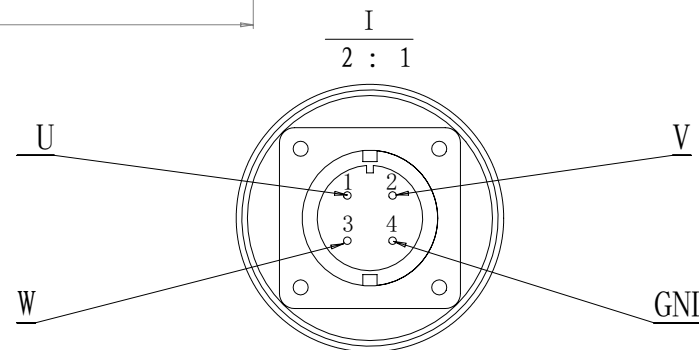
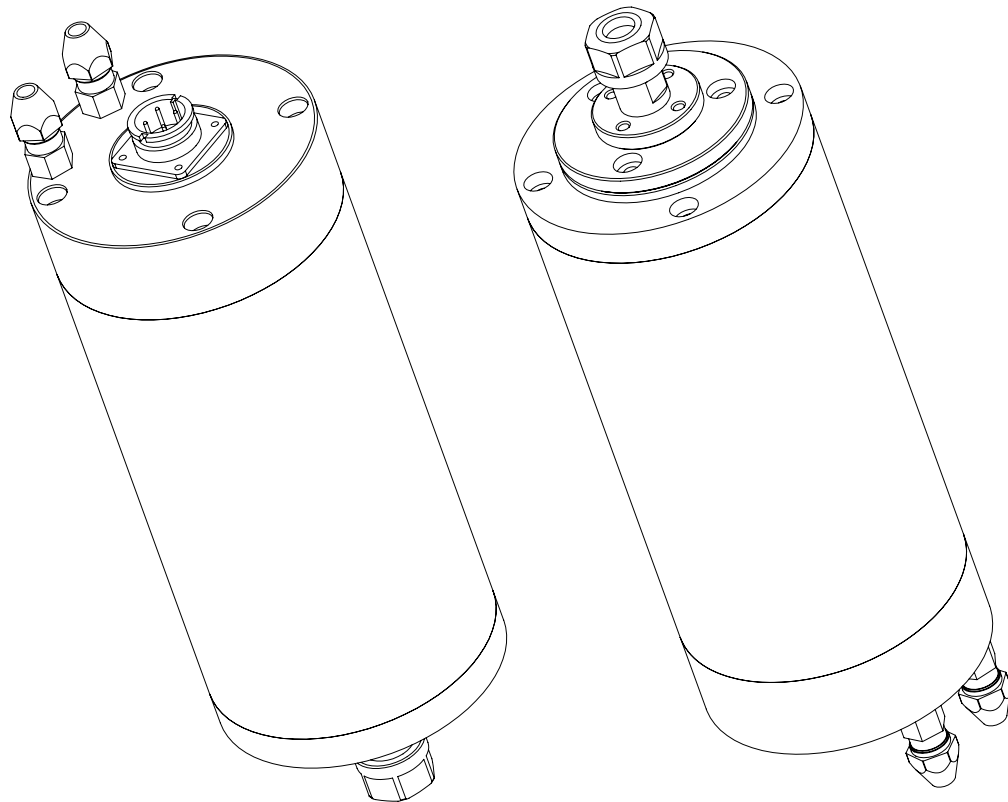
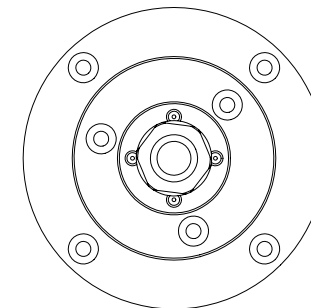
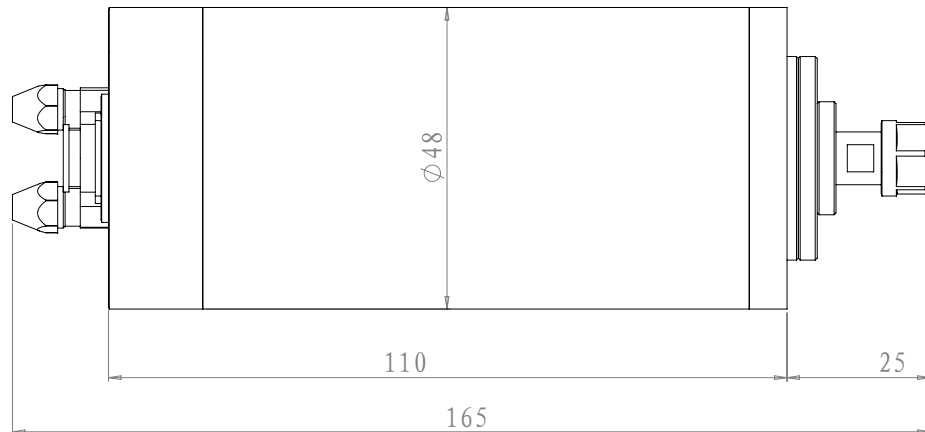
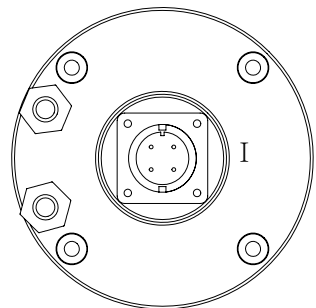

OD=48 MM , 110 MM length
Voltage: 36V
Speed: 10000-60000 R/min
Power: 100 W
Frequency: 160-1000 Hz
Water Cooling, ER collet chuck
Grease Lubrication, NSK Bearing

Keling Technology Inc
www.kelinginc.net