

This power supply is designed for used in the Step/Servo motor drive and high over loaded applications. It will work on both standard 115V and 230V at 50Hz or 60Hz. This toroidal transformer has heavier gauge wires then the normal requirement to avoid the copper lost during the full load output and over load output.

The power supply has a flexible add on option that allows more outputs as needed. Those isolated outputs can be used as logic control or encoder power supply. The main output has 2 large capacitors (10000uF x2) to guaranty the output ripple to minimum.

The chassis is made of 3/32" thick aluminum for strength and heat dissipation from rectifier and linear regulators. It will work continuous without any over heat problem.

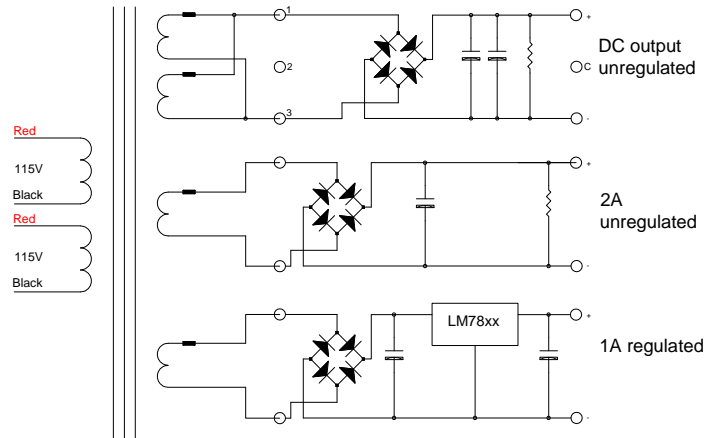
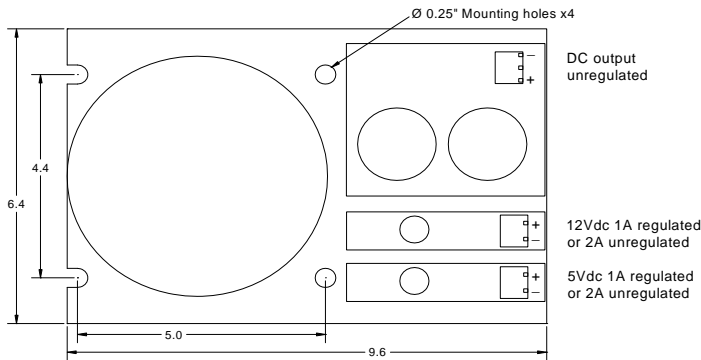

AC power connections:

115Vac – 2 red wires to neutral & 2 black wires to hot.
220Vac – 1st red wire to neutral, 1st black wire to 2nd red wire, and the 2nd black wire to hot.

Voltage output 1	Output current	Voltage ripple	Output 2	Output 3	Note:
65.0 V	0	0	5.0 V*	-	Input voltage is 120Vac at 60Hz.
61.3 V	5 A	0.4 Vrms	5.0 V*	-	
58.5 V	10 A	0.9 Vrms	5.0 V*	-	
56.5 V	15A	1.3 Vrms	5.0 V*	-	
54.6V	20A	1.7Vrms	5.0 V*	-	
52.0V	26A	2.1Vrms	5.0 V*	-	
-	-	-	-	-	
-	-	-	-	-	* linear regulated output at 1A max.